

# 03 | ANSCHLAGPROFILE

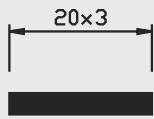

Nr. 10/44 H

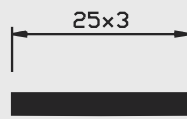

Nr. 10/43 H

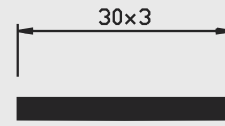

Nr. 10/42 H

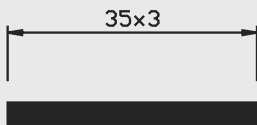

Nr. 10/41 H

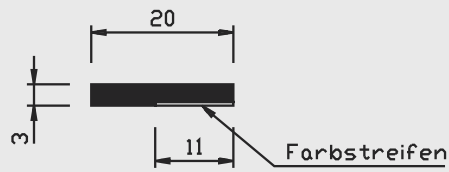

Nr. 20/44 H  
zweifarbig

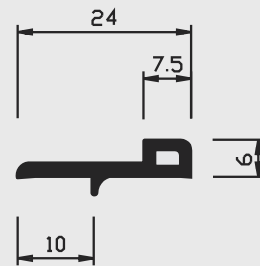

Nr. 14/43 H

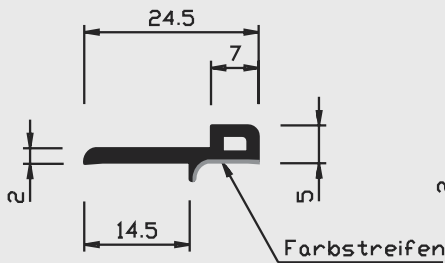

Nr. 20/43 H  
zweifarbig

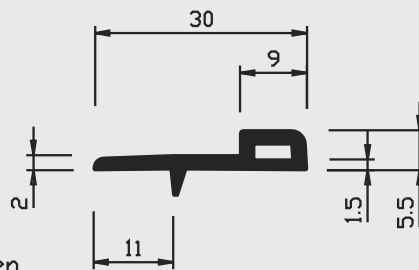

Nr. 16/43 H

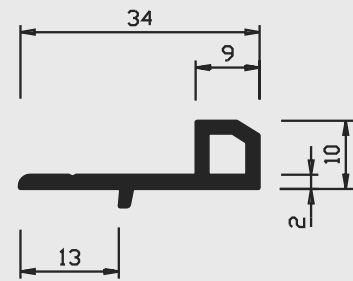

Nr. 18/43 H

= Hart PVC   
  = Weich PVC | HH = Halbhart PVC   
  = Andere Kunststoffe

# 03 | ANSCHLAGPROFILE

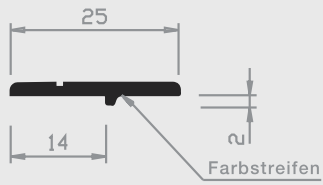

**Nr. 11/43 H**  
zweifarbig

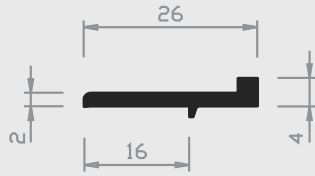

**Nr. 15/43 H**

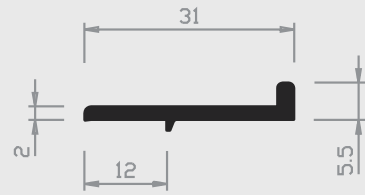

**Nr. 16/42 H**

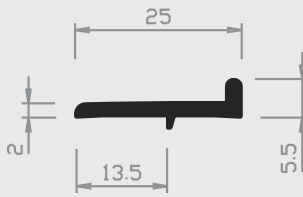

**Nr. 20/43a H 5,5mm**

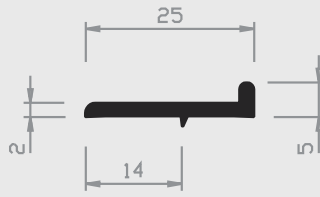

**Nr. 20/43b H 5mm**

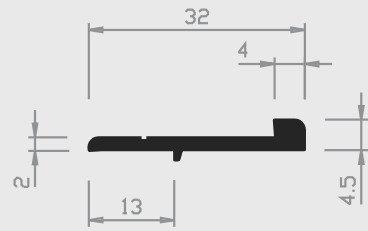

**Nr. 17/42 H**

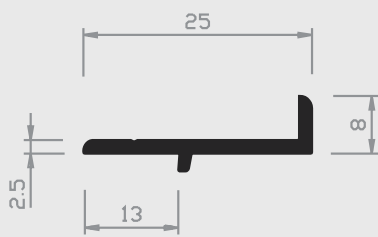

**Nr. 17/43 H**

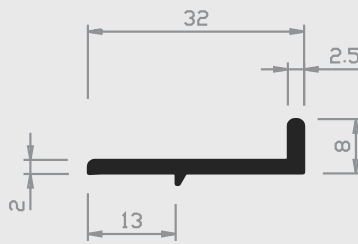

**Nr. 22/43 H 8mm**

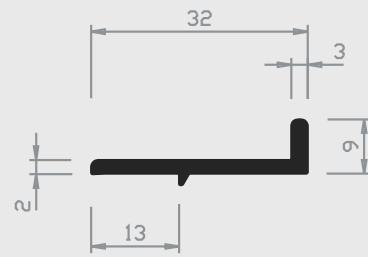

**Nr. 22/43a H 9mm**

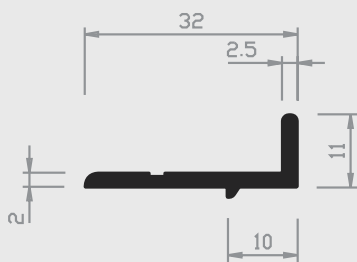

**Nr. 22/44 H**

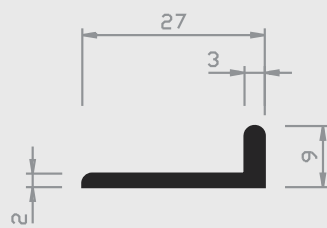

**Nr. 22/43 H**

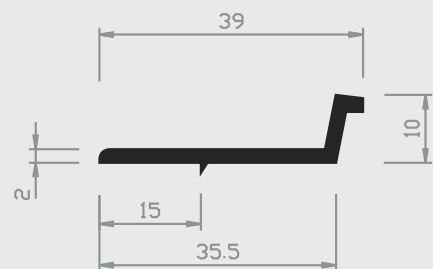

**Nr. 21/41 H**

= Hart PVC    
  = Weich PVC | HH = Halbhart PVC    
  = Andere Kunststoffe

# 03 | ANSCHLAGPROFILE

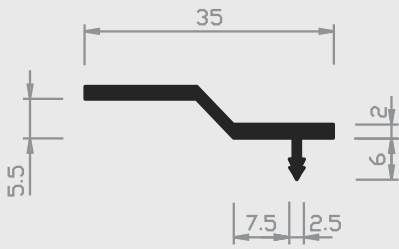

Nr. 21/40 H

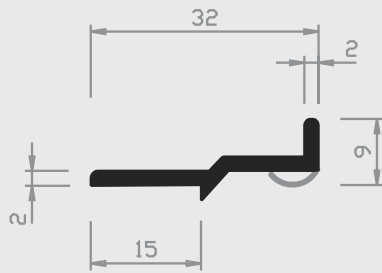

Nr. 24/43 H+W

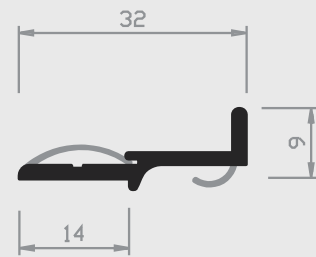

Nr. 24/43a H+W 9mm

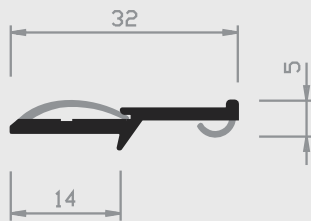

Nr. 24/43b H+W 5mm

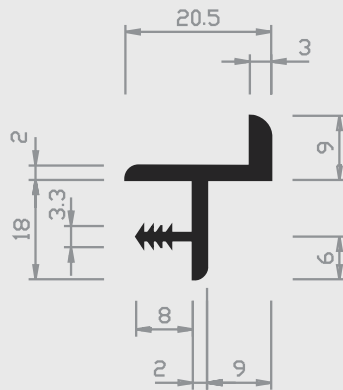

Nr. 21/43 H

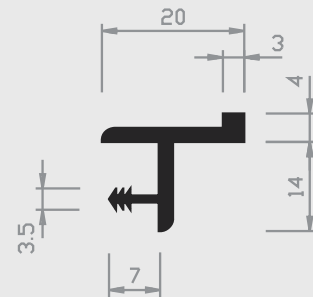

Nr. 21/43a H

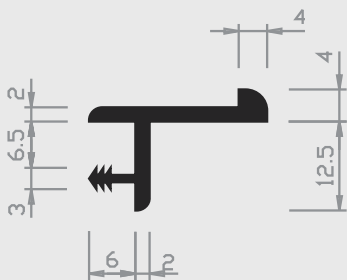

Nr. 28/43 H

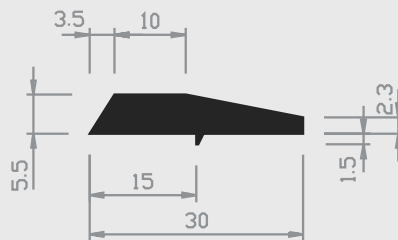

Nr. 25/43 H

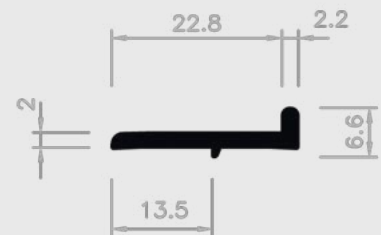

Nr. 20/43a H

= Hart PVC    
  = Weich PVC | HH = Halbhart PVC    
  = Andere Kunststoffe

# 03 | ANSCHLAGPROFILE

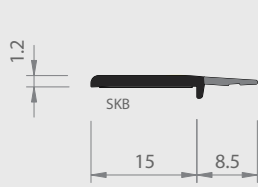

Nr.22/42 H+W  
selbstklebend

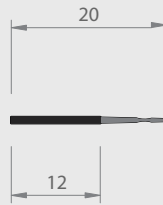

Nr.21/42a H+W 20 mm

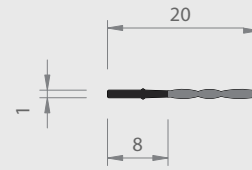

Nr.21/42b H+W



Nr.23/42 H+W

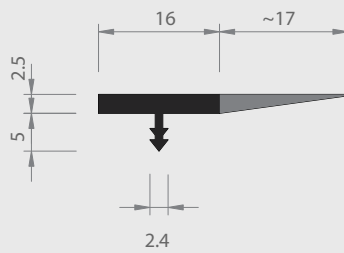

Nr.24/42 H+W

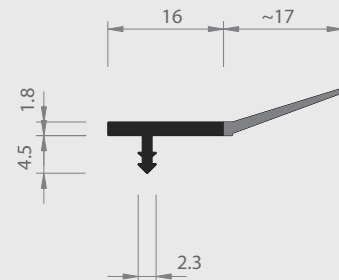

Nr.25/41 H+W

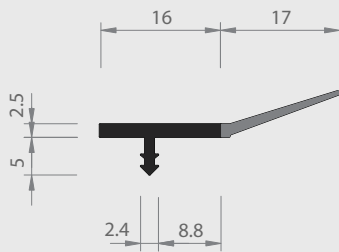

Nr.25/42 H+W

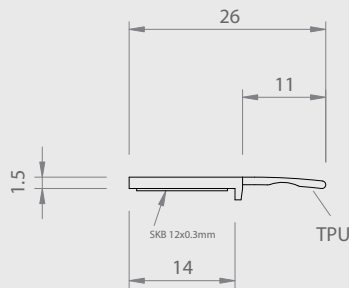

Nr. 22/39 ABS/TPU

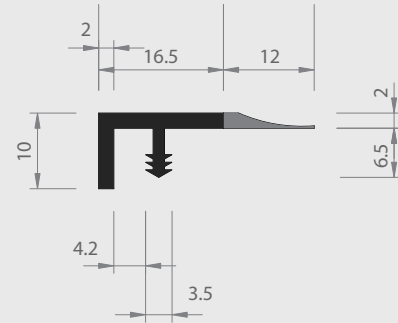

Nr.26/42 H+W

= Hart PVC
  = Weich PVC | HH = Halbhart PVC
  = Andere Kunststoffe

# 03 | ANSCHLAGPROFILE

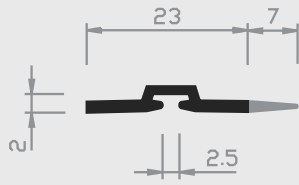

Nr. 19/42 H+W

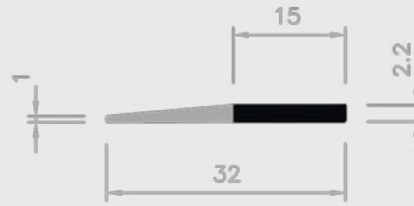

Nr. 24/42a H+W

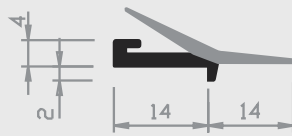

Nr. 27/42 H+W

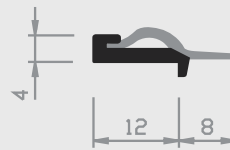

Nr. 20/45 H+W

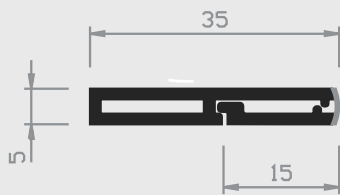

Nr. 27/43 H+W

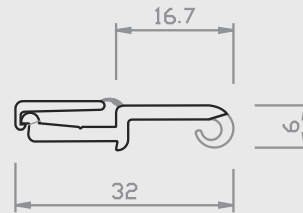

Nr. 31/43 ABS/TPU

= Hart PVC
  = Weich PVC | HH = Halbhart PVC
  = Andere Kunststoffe

# 03 | ANSCHLAGPROFILE

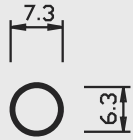

Überzugsrohr für Drehriegelschloß

Nr. 50/32 H

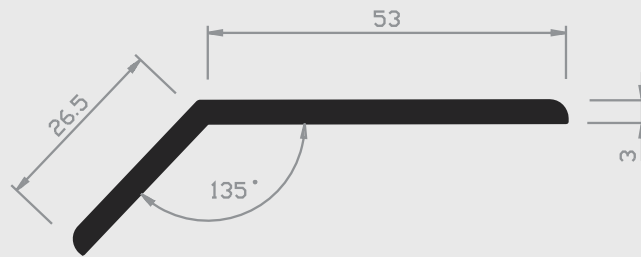

Nr. 11/18 H

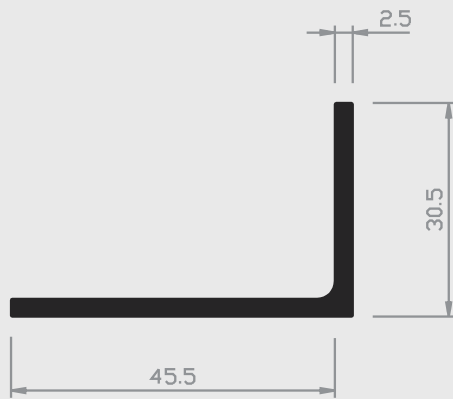

Nr. 16/63 H

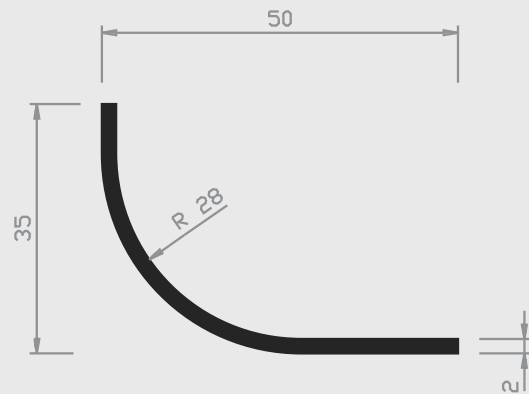

Nr. 11/17 H

■ = Hart PVC   ■ = Weich PVC | HH = Halbhart PVC   □ = Andere Kunststoffe

# 03 | ANSCHLAGPROFILE

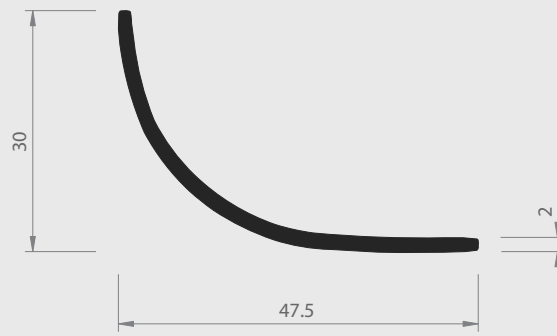

Nr. 11/17a H

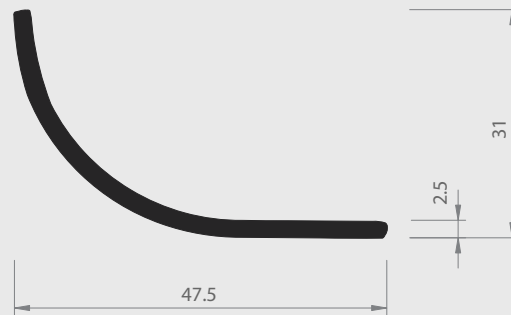

Nr. 11/17b H

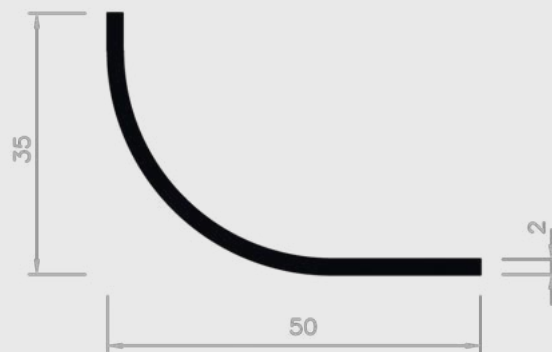

Nr. 11/17 H

■ = Hart PVC    ■ = Weich PVC | HH = Halbhart PVC    □ = Andere Kunststoffe