

09 | KANTENANLEIMER

Profile	Maße in mm	PVC - glatt	ABS - glatt	PVC - Struktur	ABS - Struktur
20/02	10 x 2		x		
15/44	15 x 2	x	x	x	x
9/44	15 x 3	x	x		
10/40	16 x 0,8	x		x	
11/44	16 x 3	x			
10/9	17 x 0,8	x			
10/9	18 x 0,8	x			
8/44	18 x 1,8	x			
10/9	19 x 0,8	x		x	x
8/11	19 x 1,5	x			
29/11	19 x 2				x
2/43	19 x 2,5	x			
10/9	20 x 0,8	x	x		
9/1	20 x 1,0	x		x	x
7/11	20 x 1,2		x		
23/11	20 x 2	x		x	
10/44	20 x 3	x		x	
13/44	20 x 4	x			
16/44	20 x 5			x	x
11/92	21 x 0,7	x	x		
23/11A	21 x 2	x			
10/10	22 x 0,8	x			
9/1	22 x 1	x	x	x	
6/43	22 x 1,2	x			
20/10	22 x 1,4	x			
7/41	22 x 2		x		x
12/43	22 x 2,5	x	x		
4/44	22 x 3	x	x	x	
14/44	22 x 6	x			
10/48	23 x 0,8	x	x	x	x
9/1	23 x 1	x	x	x	x
20/11	23 x 1,2	x	x		x
20/12	23 x 1,5	x		x	x
20/9	23 x 1,7				x
7/43	23 x 2	x	x	x	x
9/43	23 x 3	x	x	x	x
5/43	23 x 3,5	x			
3/43	23 x 4	x			

■ = Hart PVC

■ = Weich PVC | HH = Halbhart PVC

□ = Andere Kunststoffe



ZITTA
austria
plastic profiles

09 | KANTENANLEIMER

Profile	Maße in mm	PVC - glatt	ABS - glatt	PVC - Struktur	ABS - Struktur
10/10	24 x 0,8	x		x	
32/43	24 x 2		x		x
4/43	24 x 3	x		x	
10/55	25 x 0,8	x			
9/1	25 x 1	x			
17/11	25 x 1,2	x		x	
25/11	25 x 1,5	x			
18/11	25 x 2	x	x	x	x
22/11	25 x 2,5	x			
10/43	25 x 3	x	x	x	
13/43	25 x 4	x			
26/43	25 x 5	x	x		
gerundet 26/43 A	25 x 5	x	x		
10/10	26 x 0,8	x		x	x
26/11	26 x 1,2		x		x
8/41	26 x 2	x	x	x	x
11/93	27 x 0,8	x			
11/10	27 x 1	x	x		
10/10	28 x 0,8	x		x	
8/42	28 x 1,2	x			
9/42	28 x 2	x	x	x	x
30/43	28 x 3	x	x	x	
18/42	28 x 5	x			
gerundet 18/42 A	28 x 5	x	x		
10/10	29 x 0,8	x	x		
9/49	29 x 2		x		x
30/44	29 x 3		x		
gerundet 23/44	29 x 5	x			
eckig 26/44 A	29 x 5				x
10/10	30 x 0,8	x		x	
7/42	30 x 1	x	x	x	x
12/42	30 x 1,5	x		x	
13/42	30 x 2,5	x	x		
10/42	30 x 3	x	x	x	x
26/44	30 x 5	x	x		x
10/10	31 x 0,8	x			
27/11	32 x 1,2	x			

■ = Hart PVC

■ = Weich PVC | HH = Halbhart PVC

□ = Andere Kunststoffe

09 | KANTENANLEIMER

Profile	Maße in mm	PVC - glatt	ABS - glatt	PVC - Struktur	ABS - Struktur
11/42	32 x 2	x	x	x	x
10/10	32 x 0,8	x	x	x	
30/42	32 x 3	x	x	x	
11/94	33 x 0,8	x		x	
7/40	33 x 2	x	x	x	x
30/45	33 x 3				x
12/40	33 x 5	x			
gerundet 12/40 B	33 x 5	x			
10/11	34 x 0,8	x			
28/11	34 x 1,2		x		
10/11	35 x 0,8	x	x	x	
9/1	35 x 1	x			
12/11	35 x 2	x		x	
23/41	35 x 2,5	x	x	x	
10/41	35 x 3	x	x	x	x
12/41	35 x 5	x			
gerundet 12/41 B	35 x 5	x			
10/11	36 x 0,8	x			
10/11	37 x 0,8	x			
11/11	37 x 1	x			
10/11	38 x 0,8	x			
10/11	39 x 0,8	x			
10/11	40 x 0,8	x			
28/45 α	40 x 2	x			
9/41	40 x 2,5	x			
13/41	40 x 3	x			
11/41	40 x 4	x			
10/11	41 x 0,8	x			
10/11	42 x 0,8	x			
10/11	43 x 0,8	x			
10/11	44 x 0,8	x			
9/11	45 x 0,5	x			
10/11	45 x 0,8	x		x	
9/1	45 x 1	x			
21/11	45 x 1,2				
22/40	45 x 2	x		x	x
22/41	45 x 3	x		x	x

■ = Hart PVC

■ = Weich PVC | HH = Halbhart PVC

□ = Andere Kunststoffe



09 | KANTENANLEIMER

Profile	Maße in mm	PVC - glatt	ABS - glatt	PVC - Struktur	ABS - Struktur
16/12	50 x 1,8	x			
15/41	50 x 3	x		x	
10/11	51-55 x 0,8	x			
10/11	53 x 1	x		x	
16/11	51-55 x 1,2	x			
14/41 A	54 x 2,8				
29/41	55 x 2				x
14/41	55 x 3	x	x		
24/41	55 x 4	x			
24/44	55 x 5	x			
10/11	56-65 x 0,8	x			
16/11	56-65 x 1,2	x			

■ = Hart PVC

■ = Weich PVC | HH = Halbhart PVC

□ = Andere Kunststoffe

09 | KANTENANLEIMER

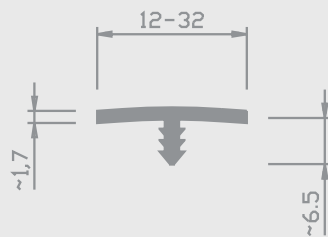

Nr. 10/7
HH od. H

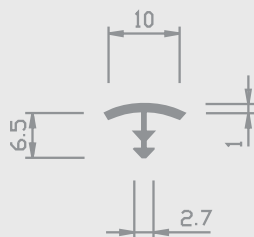

Nr. 10/20 W

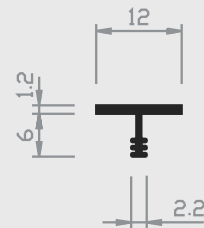

Nr. 10/85 H

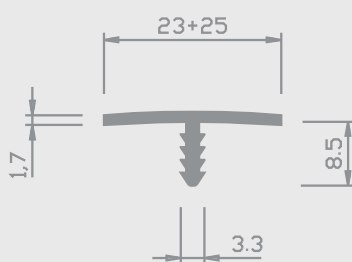

Nr. 13/7 HH 23mm
Nr. 13/7 HH 25mm

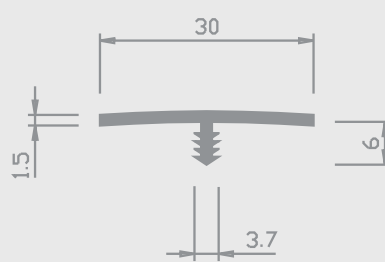

Nr. 14/7 HH

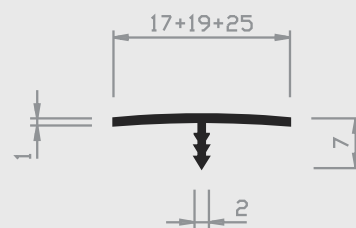

Nr. 19/7 H 17mm
Nr. 19/7 H 19mm
Nr. 19/7 H 25mm

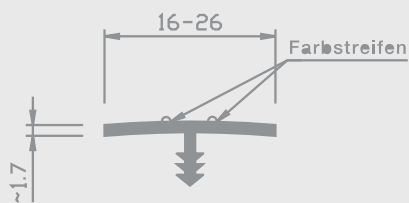

Nr. 20/7 HH
zweifärbig

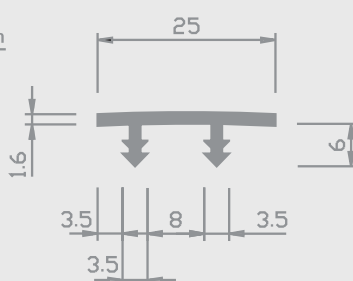

Nr. 12/7 HH

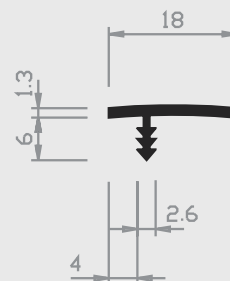

Nr. 8/7 H

= Hart PVC
 = Weich PVC | HH = Halbhart PVC
 = Andere Kunststoffe

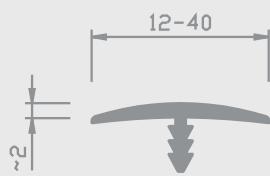

Nr. 10/1 HH

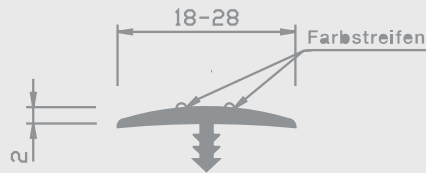

Nr. 20/1 HH
zweifarbig

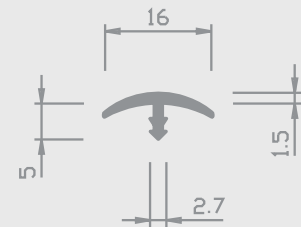

Nr. 10/19 W

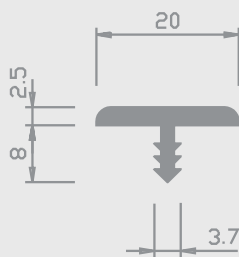

Nr. 16/7 HH

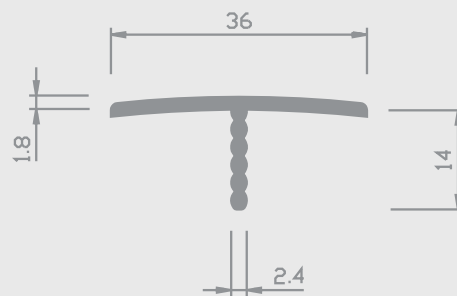

Nr. 17/7 HH

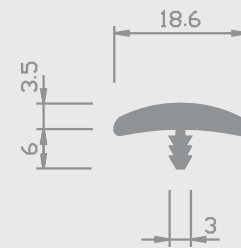

Nr. 18/2 HH

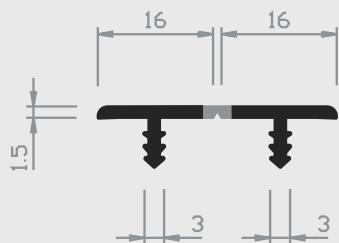

Nr. 12/84 H+W

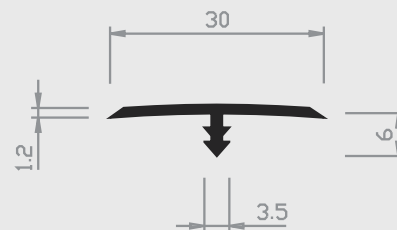

Nr. 21/7 H

= Hart PVC
 = Weich PVC | HH = Halbhart PVC
 = Andere Kunststoffe

09 | KANTENANLEIMER

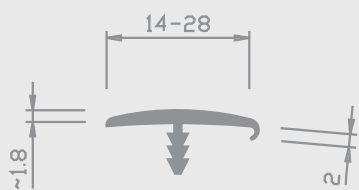

Nr. 10/2 HH

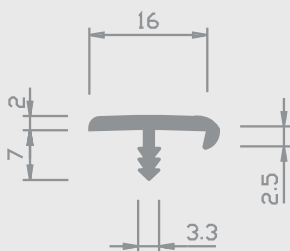

Nr. 10/2a W

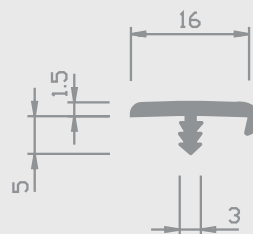

Nr. 10/2b W

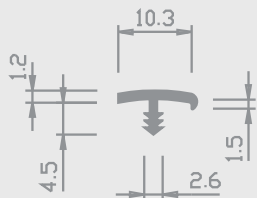

Nr. 10/80 HH



Nr. 10/3 HH

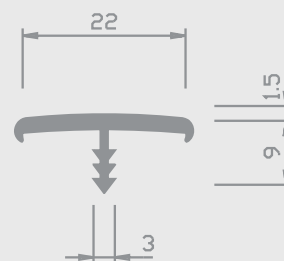

Nr. 10/5 HH 22mm

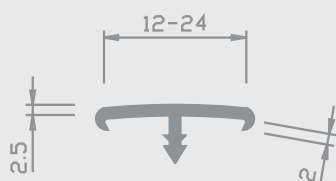

Nr. 10/6 HH

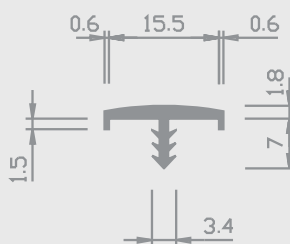

Nr. 10/6a W

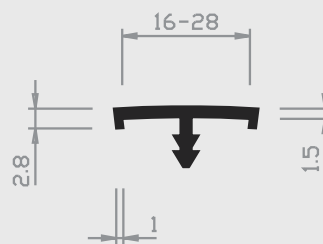

Nr. 10/8 H

= Hart PVC
 = Weich PVC | HH = Halbhart PVC
 = Andere Kunststoffe

09 | KANTENANLEIMER

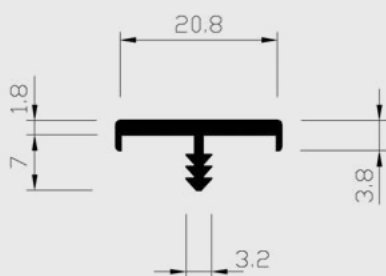

Nr. 12/38 H

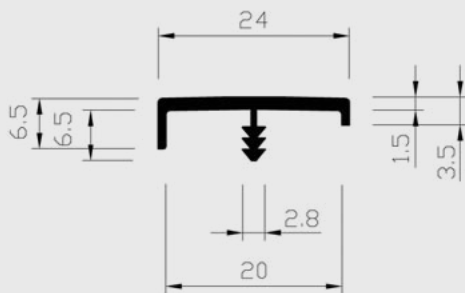

Nr. 12/16 H

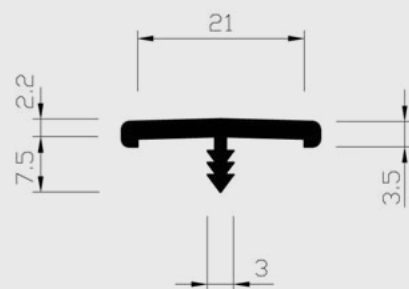

Nr. 12/08 H

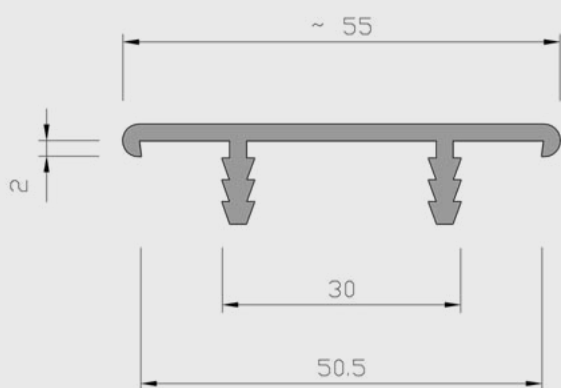

Nr. 10/03 HH 50mm

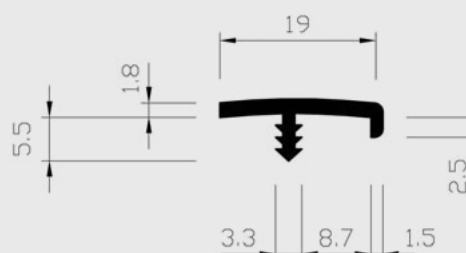

Nr. 12/52 H

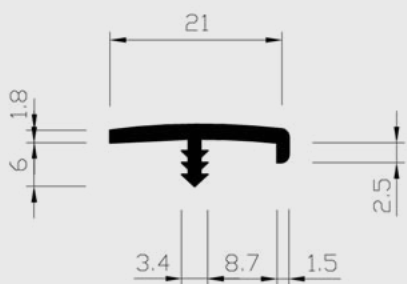

Nr. 12/52a H

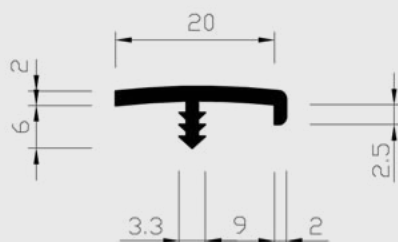

Nr. 12/52b H

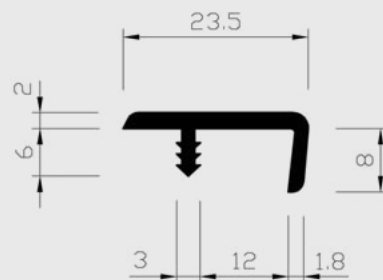

Nr. 10/47 H

= Hart PVC
 = Weich PVC | HH = Halbhart PVC
 = Andere Kunststoffe

09 | KANTENANLEIMER

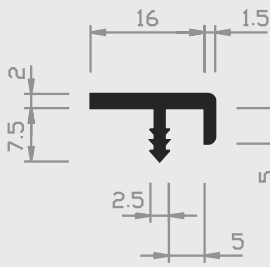

Nr. 12/47 H

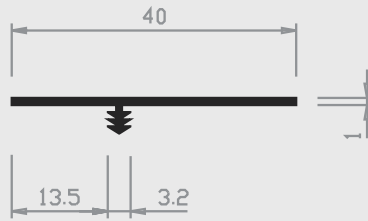

Nr. 22/7 H

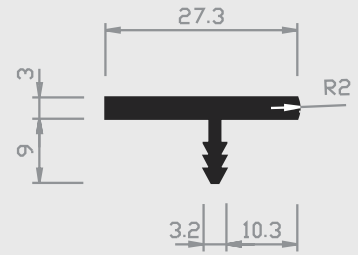

Nr. 9/7 H

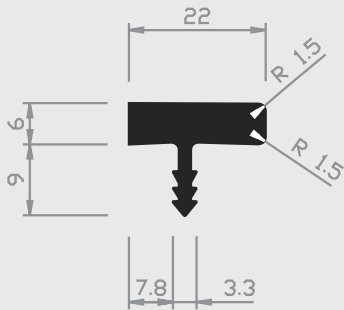

Nr. 9/8 H

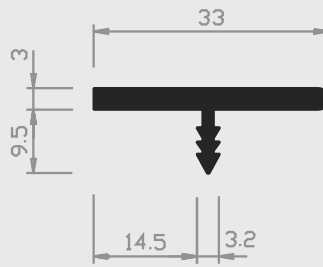

Nr. 9/10 H

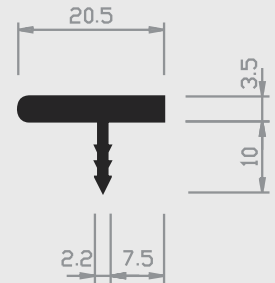

Nr. 23/7 H

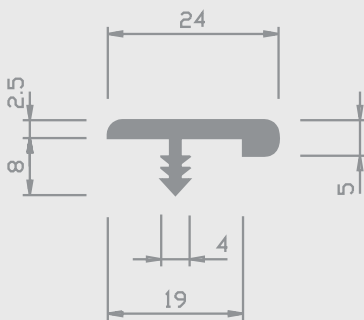

Nr. 15/7 HH

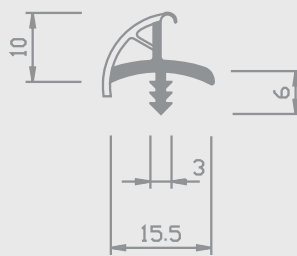

Nr. 12/49 HH+W

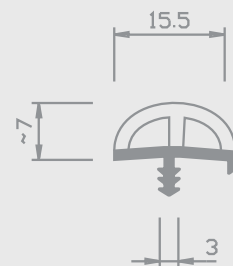

Nr. 12/50 HH+W

■ = Hart PVC

■ = Weich PVC | HH = Halbhart PVC

□ = Andere Kunststoffe

09 | KANTENANLEIMER



Nr. 18/05A W

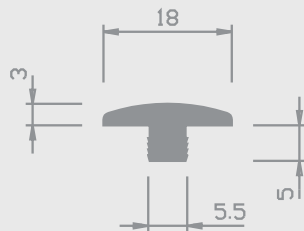

Nr. 18/7 HH

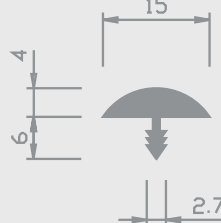

Nr. 18/8 W

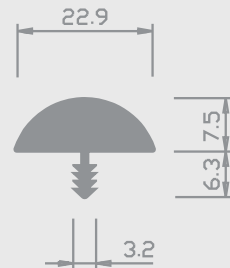

Nr. 18/9 W 22mm



Nr. 18/10 W 19mm

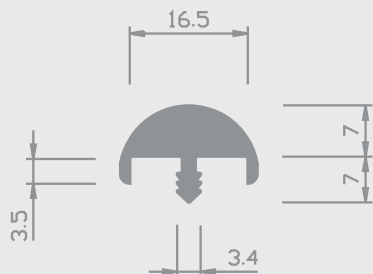

Nr. 9/2 HH

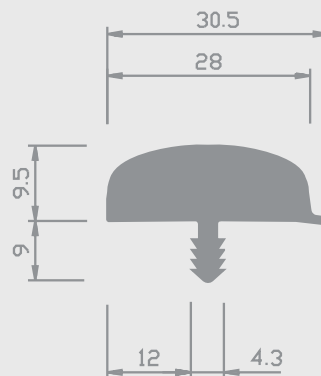

Nr. 11/29 HH

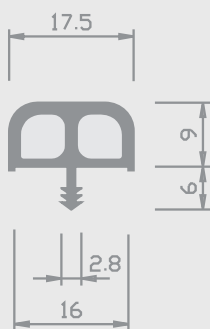

Nr. 10/29 W



Nr. 18/3 HH



Nr. 18/5 W

■ = Hart PVC

■ = Weich PVC | HH = Halbhart PVC

□ = Andere Kunststoffe

09 | KANTENANLEIMER

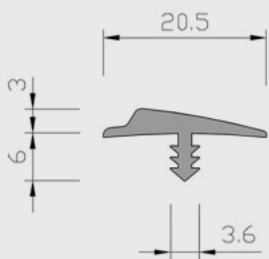

Nr. 10/4 HH

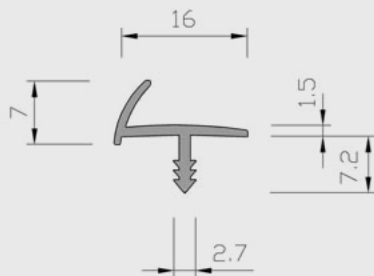

Nr. 12/48 W

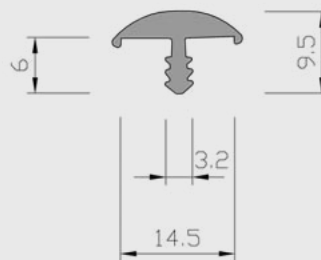

Nr. 18/49 W

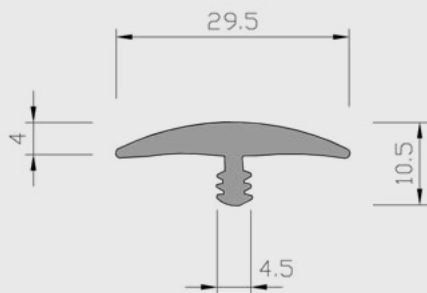

Nr. 18/50 W

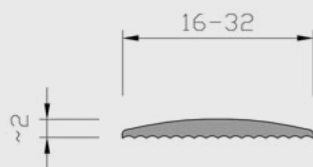

Nr. 11/01 HH

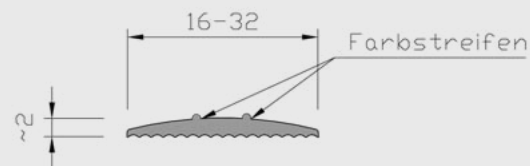

Nr. 21/01 HH
zweifarbig

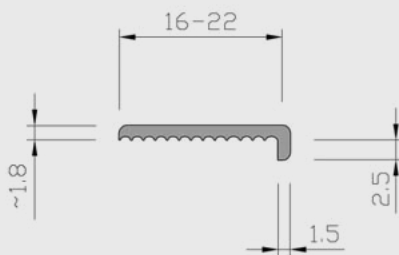

Nr. 07/06 HH

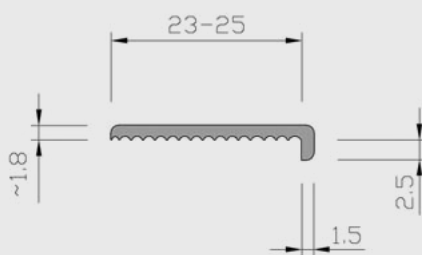

Nr. 08/06 HH

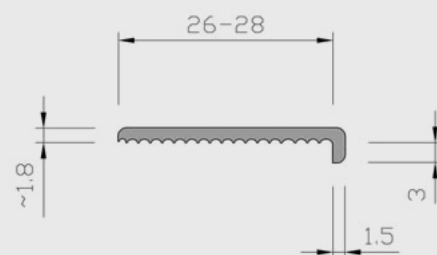

Nr. 09/06 HH

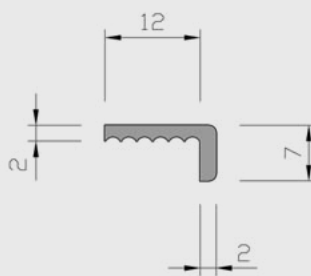

Nr. 40/38 HH

■ = Hart PVC

■ = Weich PVC | HH = Halbhart PVC

□ = Andere Kunststoffe

09 | KANTENANLEIMER

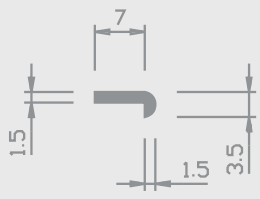

Nr. 10/77 HH

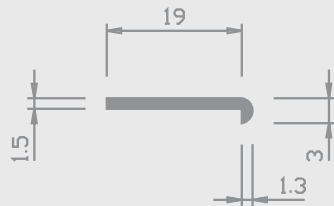

Nr. 10/78 HH

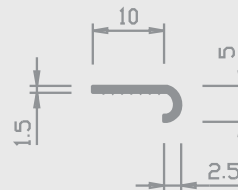

Nr. 11/77 HH

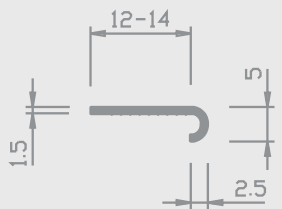

Nr. 11/78 HH

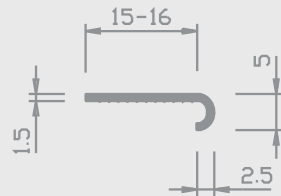

Nr. 11/79 HH

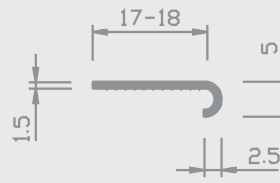

Nr. 12/77 HH

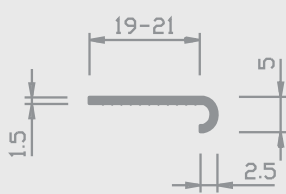

Nr. 12/78 HH

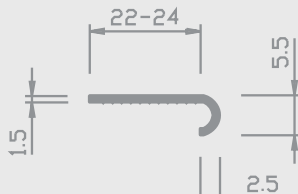

Nr. 12/79 HH

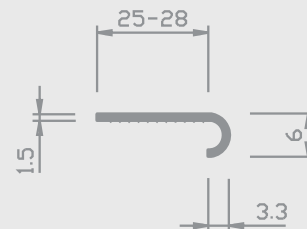

Nr. 13/77 HH

= Hart PVC
 = Weich PVC | HH = Halbhart PVC
 = Andere Kunststoffe

09 | KANTENANLEIMER

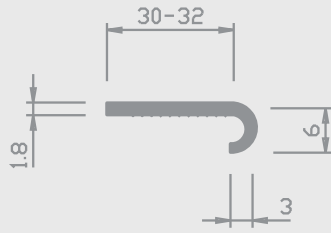

Nr. 13/78 HH

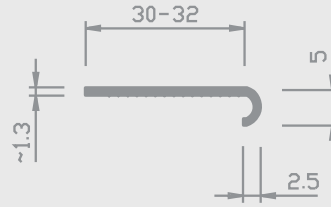

Nr. 14/78 HH

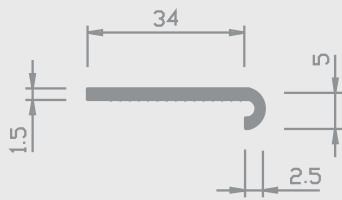

Nr. 15/78 HH

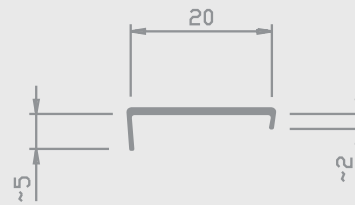

Nr. 12/17 HH

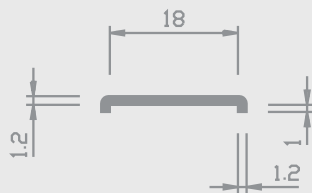

Nr. 16/16 HH

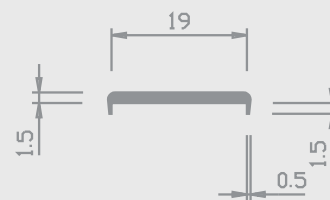

Nr. 16/17 HH

= Hart PVC
 = Weich PVC | HH = Halbhart PVC
 = Andere Kunststoffe

09 | KANTENANLEIMER

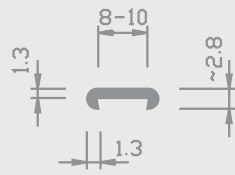

Nr. 14/6 HH

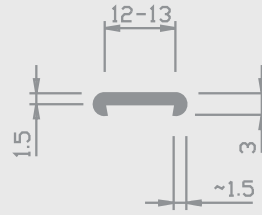

Nr. 15/6 HH

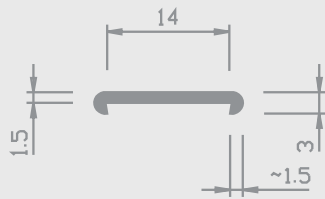

Nr. 16/6 HH

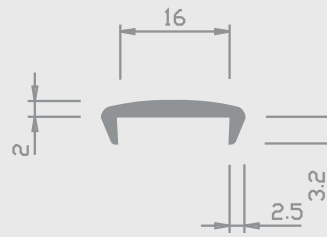

Nr. 17/6 HH

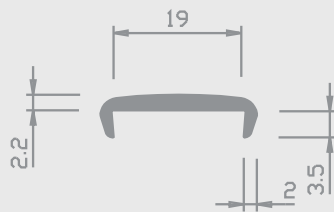

Nr. 18/6 HH
x = 18+19+20+28

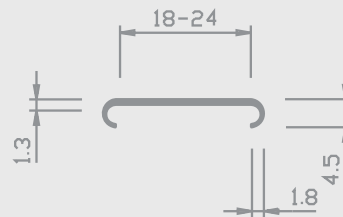

Nr. 22/6 HH

= Hart PVC
 = Weich PVC | HH = Halbhart PVC
 = Andere Kunststoffe

09 | KANTENANLEIMER



Nr. 11/4 H

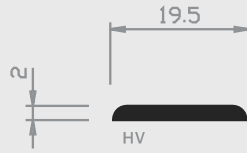

Nr. 11/4a H



Nr. 11/8 H

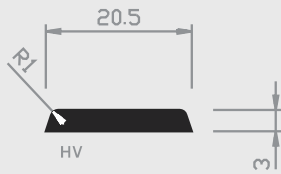

Nr. 11/9 H

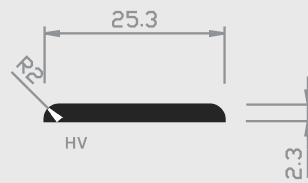

Nr. 11/12 H

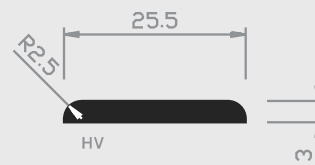

Nr. 11/13 H



Nr. 11/19 H



Nr. 11/20 H

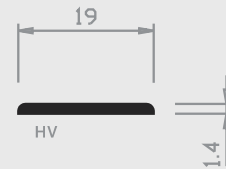

Nr. 5/44 H

= Hart PVC
 = Weich PVC | HH = Halbhart PVC
 = Andere Kunststoffe

09 | KANTENANLEIMER

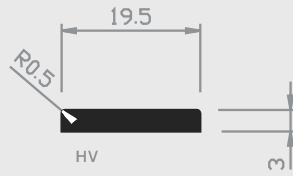

Nr. 10/31 H

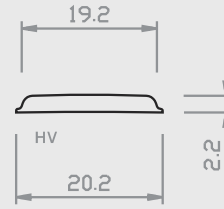

Nr. 25/3 ABS



Nr. 25/4 ABS

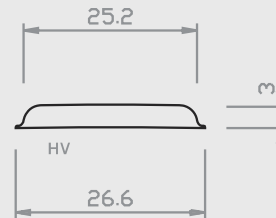

Nr. 25/5 ABS

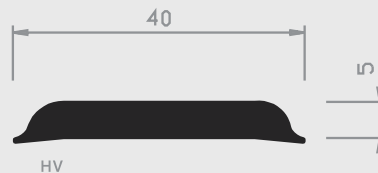

Nr. 11/40 H

= Hart PVC
 = Weich PVC | HH = Halbhart PVC
 = Andere Kunststoffe

09 | KANTENANLEIMER

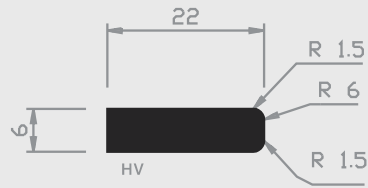

Nr. 9/8a H

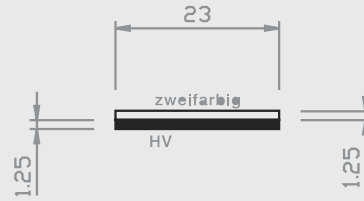

Nr. 3/42 H

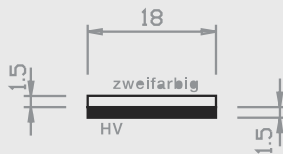

Nr. 9/56 H



Nr. 10/49 H



Nr. 10/56 H



Nr. 10/51 H

= Hart PVC
 = Weich PVC | HH = Halbhart PVC
 = Andere Kunststoffe

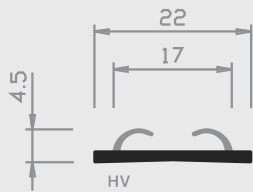

Nr. 22/17 H+W

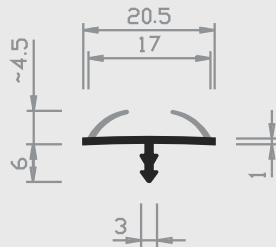

Nr. 22/19 H+W

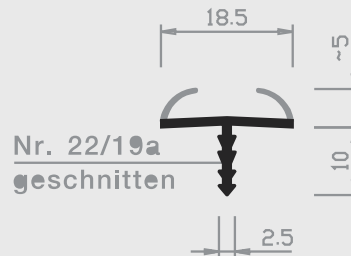

Nr. 22/19a geschnitten H+W

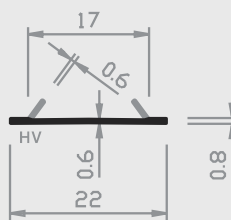

Nr. 23/17 H+W

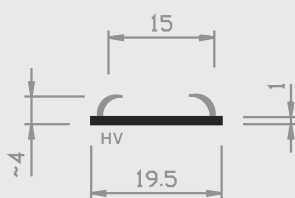

Nr. 23/19 H+W

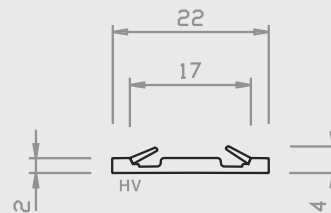

Nr. 23/16 ABS/TPU

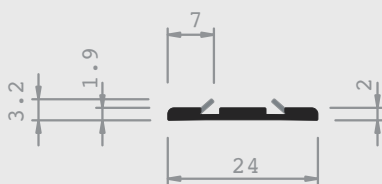

Nr. 22/09 H+W

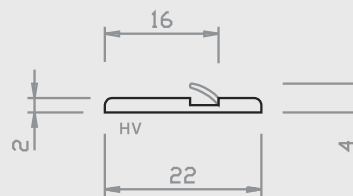

Nr. 25/16 ABS/TPU

= Hart PVC
 = Weich PVC | HH = Halbhart PVC
 = Andere Kunststoffe

09 | KANTENANLEIMER

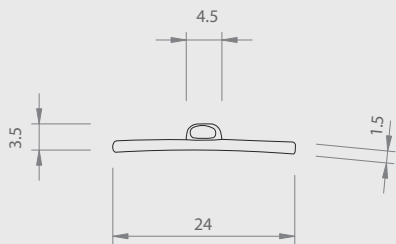

Nr. 22/08a ABS+TPU

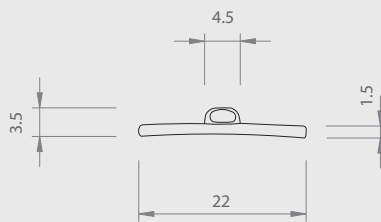

Nr. 22/08 ABS+TPU

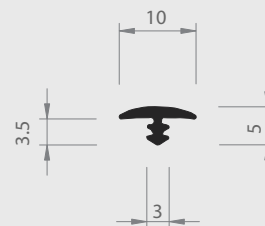

Nr. 10/01 10mm H

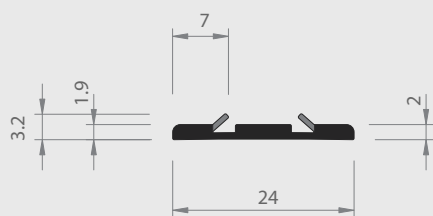

Nr. 22/09 H+W

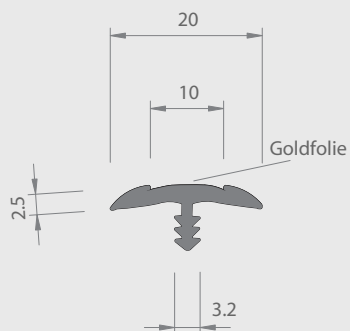

Nr. 08/01 W



Nr. 10/01 HH

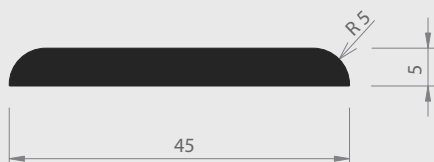

Nr. 22/49 H

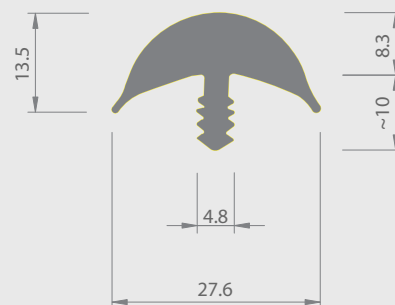

Nr. 18/48 W

■ = Hart PVC

■ = Weich PVC | HH = Halbhart PVC

□ = Andere Kunststoffe

09 | KANTENANLEIMER

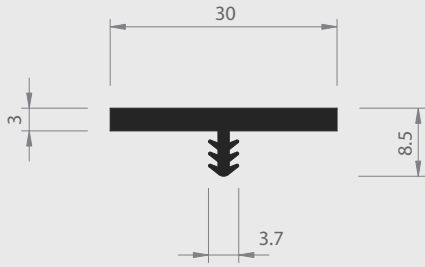

Nr.23/26 H

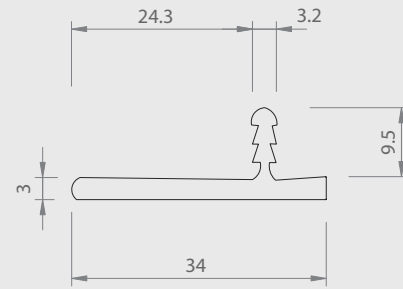

Nr.9/45 PP

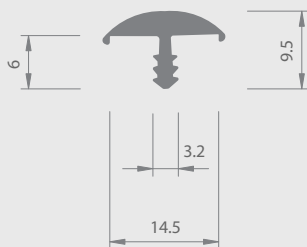

Nr.18/49 W

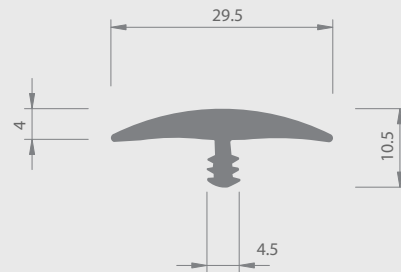

Nr.18/50 W

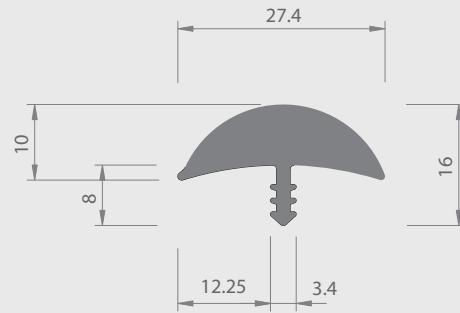

Nr.18/60 W

= Hart PVC
 = Weich PVC | HH = Halbhart PVC
 = Andere Kunststoffe

09 | KANTENANLEIMER

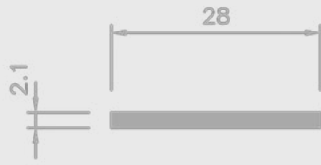

Nr. 22/1 W

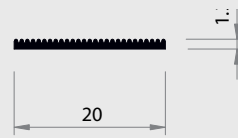

Nr. 23/11b H

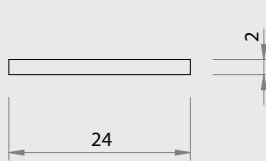

Nr. 06/49 TPU

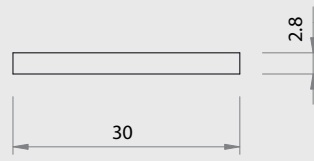

Nr. 06/50 TPU

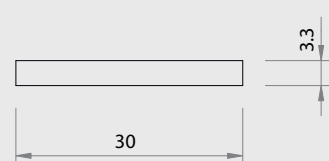

Nr. 06/51 TPU

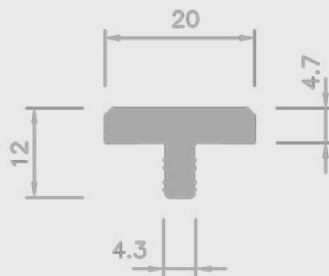

Nr. 19/29a W

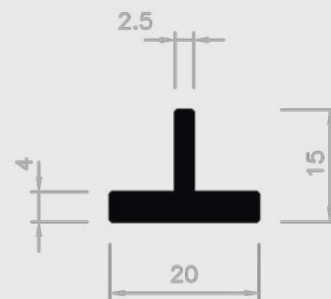

Nr. 20/3 H

= Hart PVC
 = Weich PVC | HH = Halbhart PVC
 = Andere Kunststoffe