

21 | SPROSSENPROFILE

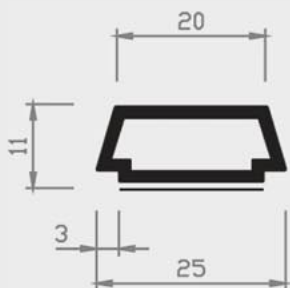

**Nr. 27/62 H
selbstklebend**

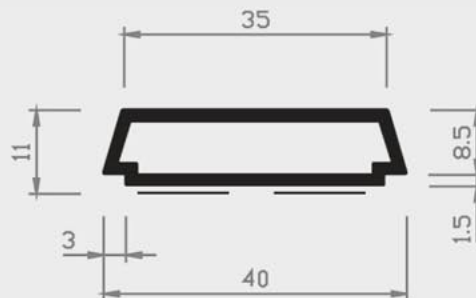

**Nr. 27/62a H
selbstklebend**



**Nr. 27/66 H
selbstklebend**



**Nr. 27/65 H
selbstklebend**



Nr. 27/64 H selbstklebend

= Hart PVC
 = Weich PVC | HH = Halbhart PVC
 = Andere Kunststoffe

21 | SPROSSENPROFILE

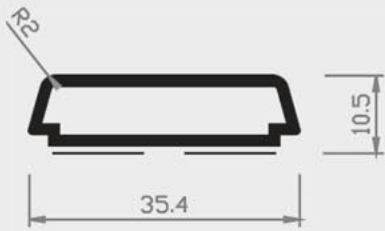

Nr. 27/80 H
selbstklebend
geschützt

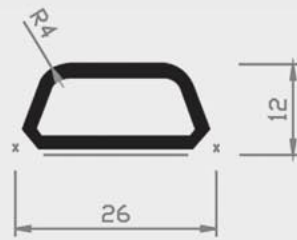

Nr. 27/75 H selbst-
klebend

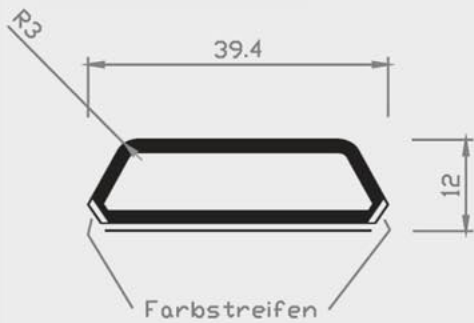

Nr. 27/76c H
selbstklebend
geschützt

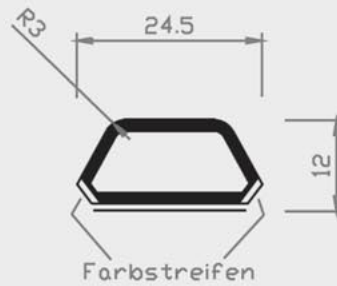

Nr. 27/75c H selbstkle-
bend
geschützt

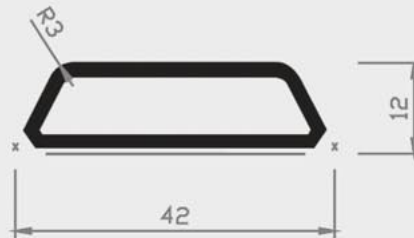

Nr. 27/76 H selbst-
klebend

= Hart PVC
 = Weich PVC | HH = Halbhart PVC
 = Andere Kunststoffe

21 | SPROSSENPROFILE

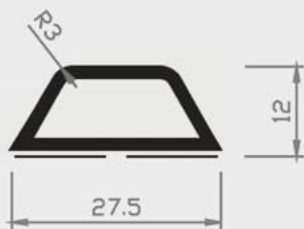

Nr. 27/75a H
selbstklebend

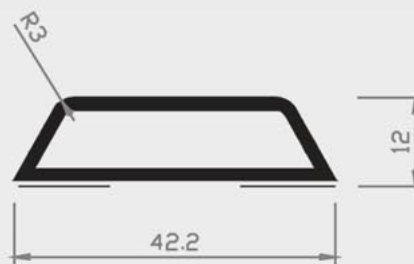

Nr. 27/76a H
selbstklebend

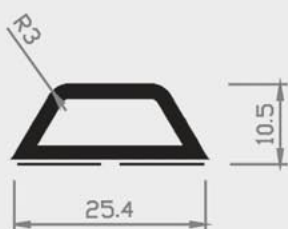

Nr. 27/75b H
selbstklebend

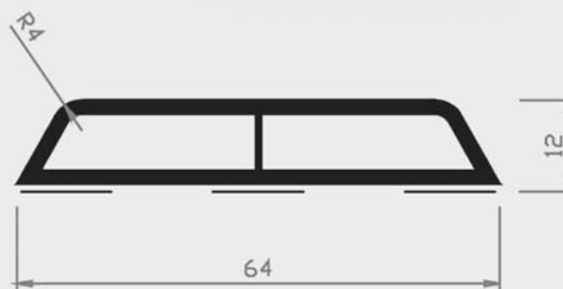

Nr. 27/81a H selbstklebend

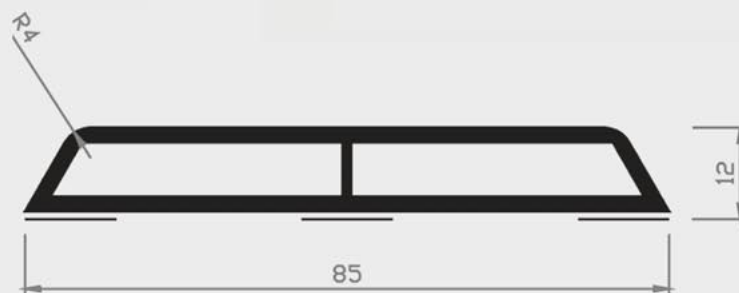

Nr. 27/82a H selbstklebend

= Hart PVC
 = Weich PVC | HH = Halbhart PVC
 = Andere Kunststoffe

21 | SPROSSENPROFILE

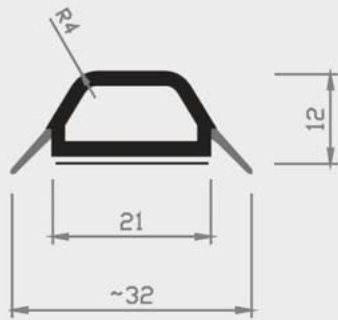

Nr. 27/77 H+W
selbstklebend

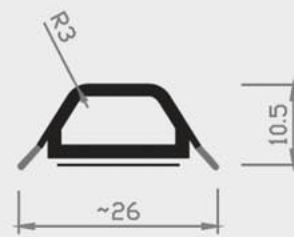

Nr. 27/77a H+W
selbstklebend

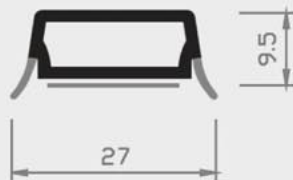

Nr. 27/71 H+W
selbstklebend

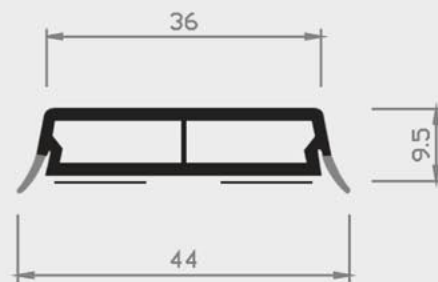

Nr. 27/72 H+W
selbstklebend

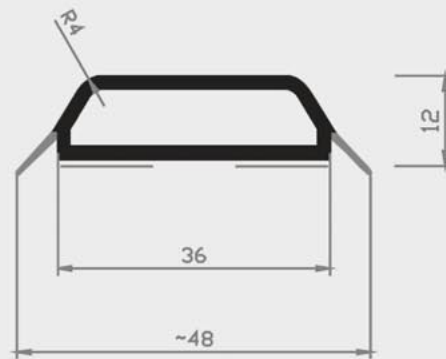

Nr. 27/78 H+W
selbstklebend

= Hart PVC
 = Weich PVC | HH = Halbhart PVC
 = Andere Kunststoffe

21 | SPROSSENPROFILE

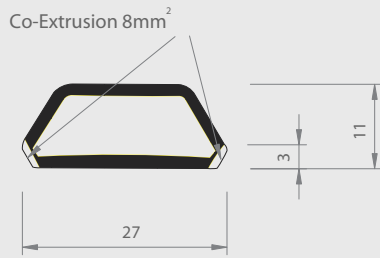

Nr. 28/75c H

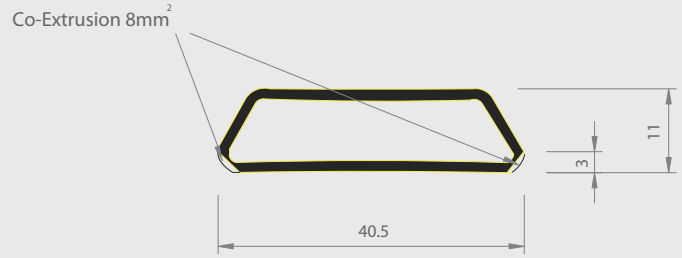

Nr. 28/76c H

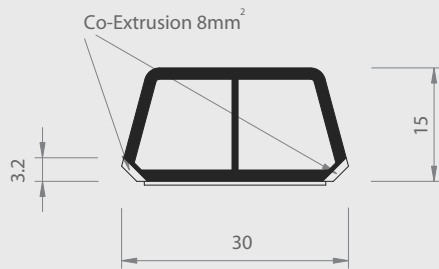

Nr. 28/77 H

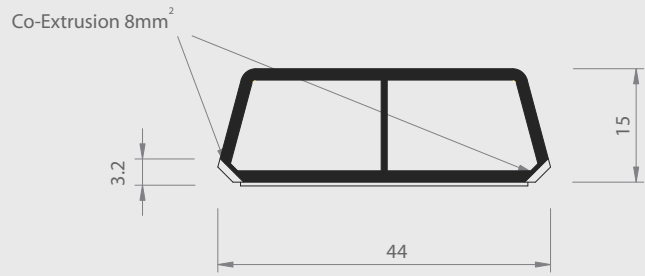

Nr. 28/78 H

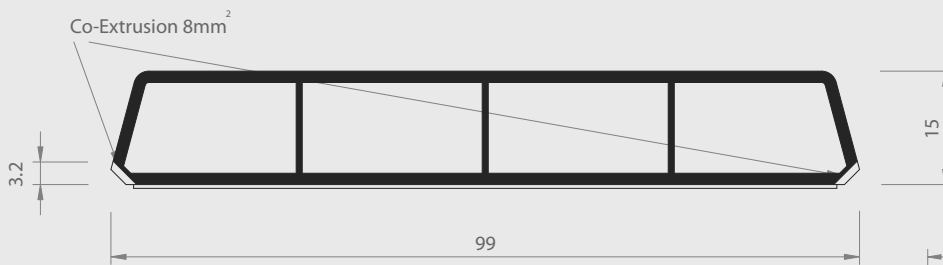

Nr. 28/79 H

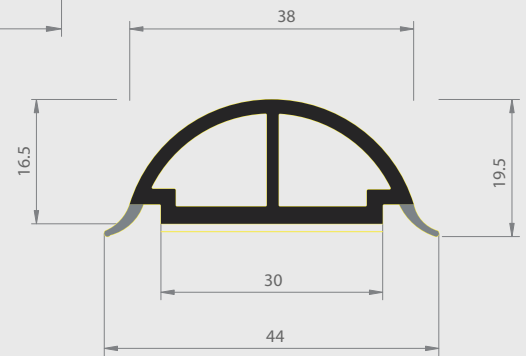

Nr. 27/83 H+W

= Hart PVC
 = Weich PVC | HH = Halbhart PVC
 = Andere Kunststoffe

21 | SPROSSENPROFILE

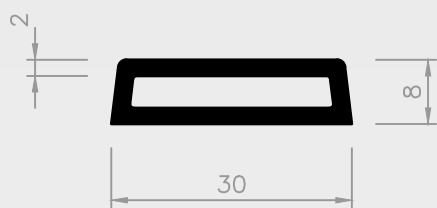

Nr. 28/80 H

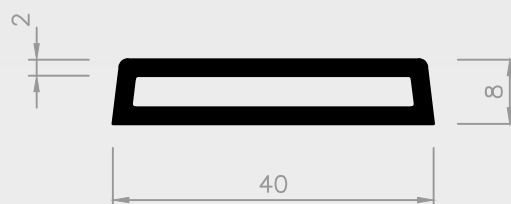

Nr. 28/81 H

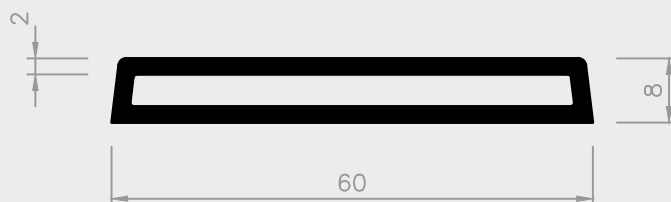

Nr. 28/82 H

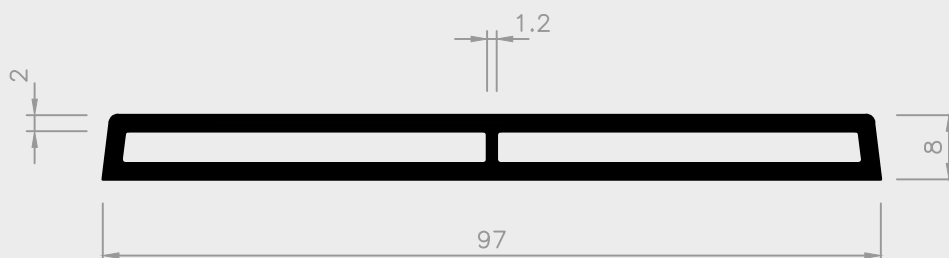

Nr. 28/83 H

■ = Hart PVC ■ = Weich PVC | HH = Halbhart PVC □ = Andere Kunststoffe