

# 24 | U - PROFILE

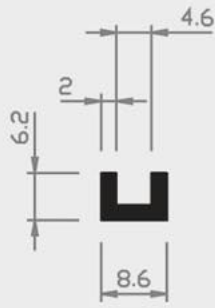

Nr. 43/36 H



Nr. 31/36 H

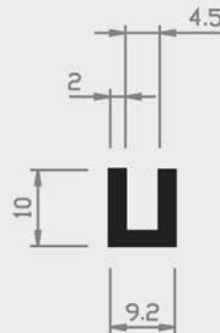

Nr. 27/36 H

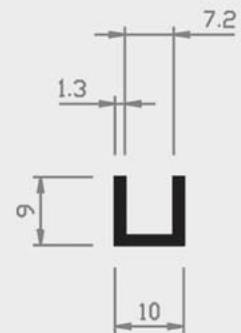

Nr. 10/36 H

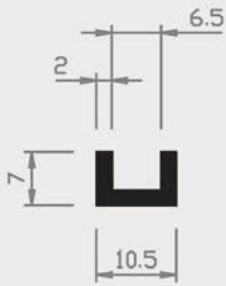

Nr. 30/36 H

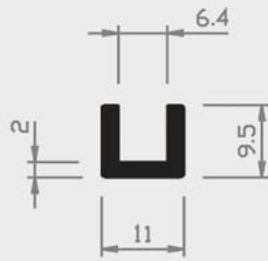

Nr. 13/36 H



Nr. 59/36 H



Nr. 13/36a H

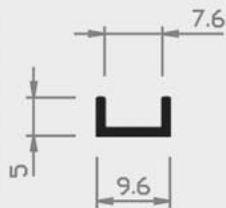

Nr. 38/36 H

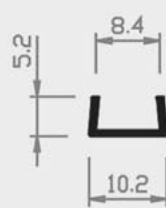

Nr. 19/36 H

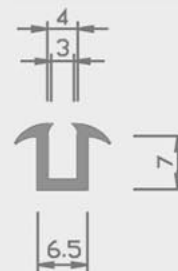

Nr. 16/14 H

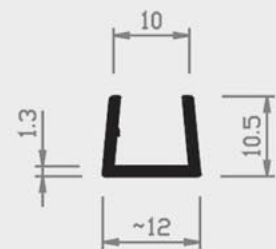

Nr. 40/36 H

= Hart PVC    
  = Weich PVC | HH = Halbhart PVC    
  = Andere Kunststoffe

# 24 | U - PROFILE

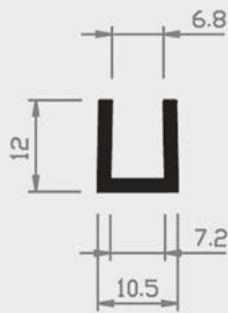

Nr. 5/36 H

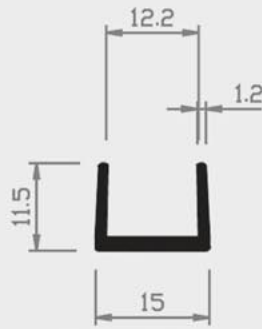

Nr. 21/36 H

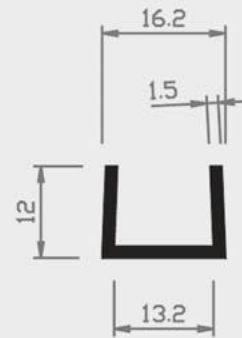

Nr. 23/36 H

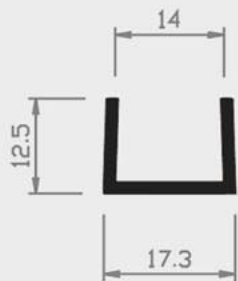

Nr. 23/36a H

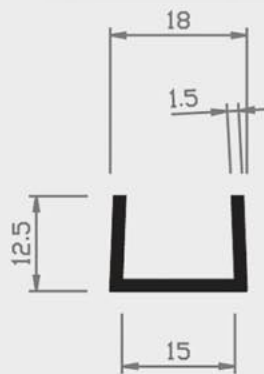

Nr. 26/36 H

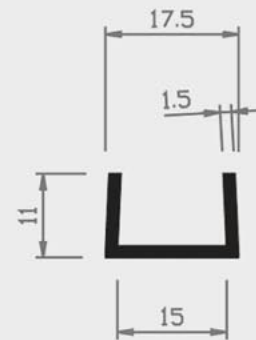

Nr. 22/36 H

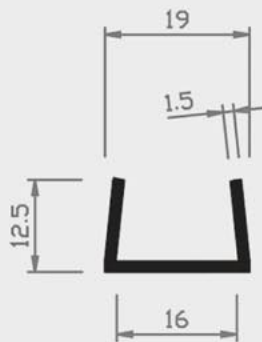

Nr. 24/36 H

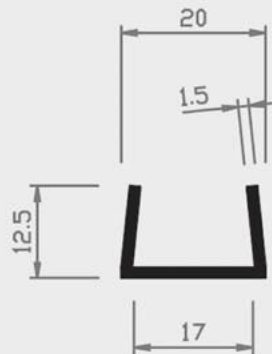

Nr. 24/36a H

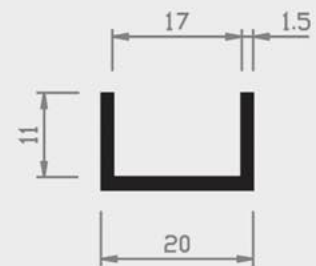

Nr. 24/36b H

= Hart PVC   
  = Weich PVC | HH = Halbhart PVC   
  = Andere Kunststoffe

# 24 | U - PROFILE

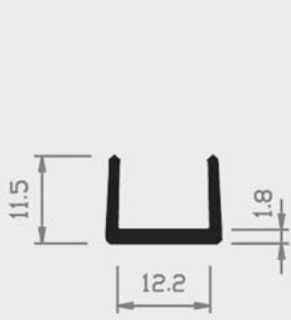

Nr. 21/36a H

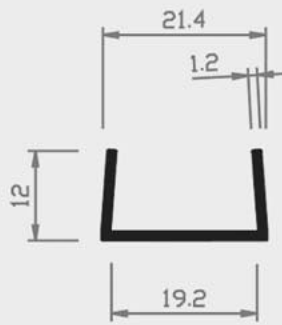

Nr. 48/36 H

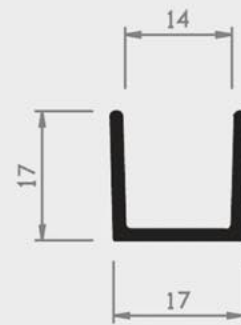

Nr. 29/36 H

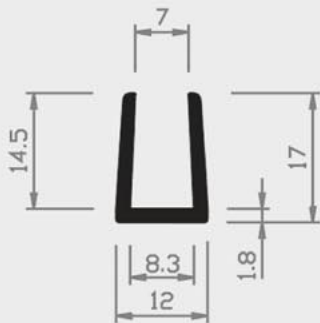

Nr. 34/36 H

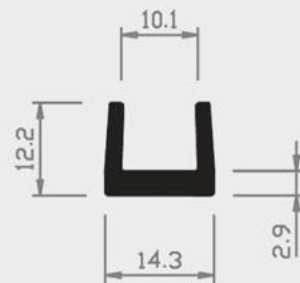

Nr. 55/36 H

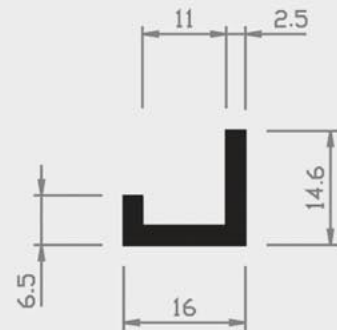

Nr. 18/37 H

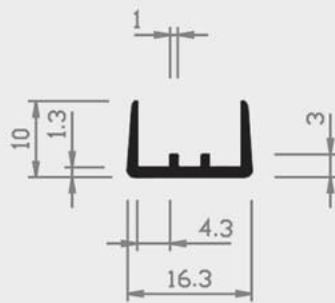

Nr. 41/36 H

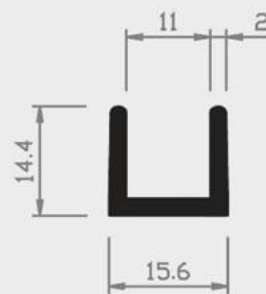

Nr. 28/36 H

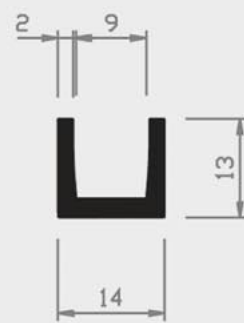

Nr. 18/36 H

■ = Hart PVC

■ = Weich PVC | HH = Halbhart PVC

□ = Andere Kunststoffe

# 24 | U - PROFILE

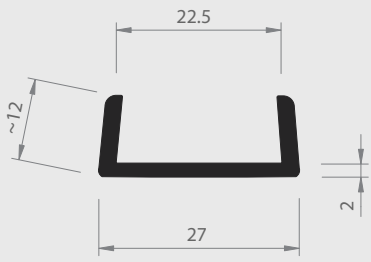

Nr. 46/36 H

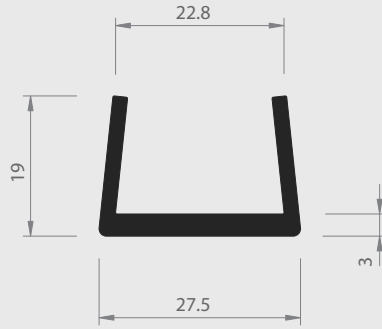

Nr. 20/36 H

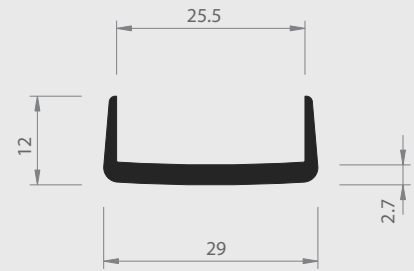

Nr. 35/36 H

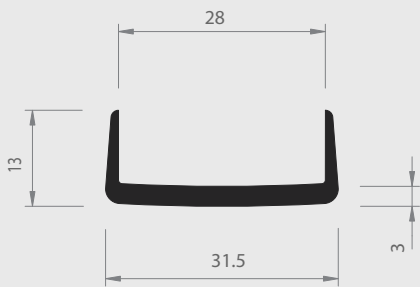

Nr. 35/36a H

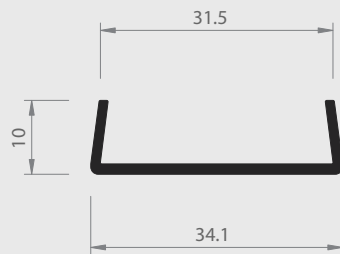

Nr. 25/36 H

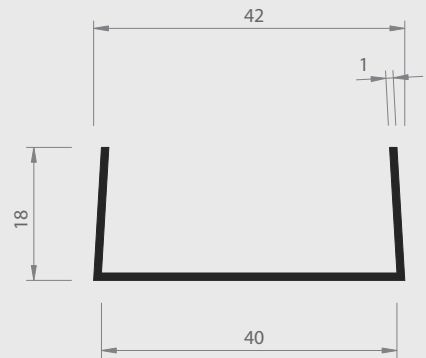

Nr. 50/36 H

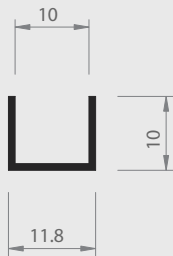

Nr. 31/37 H

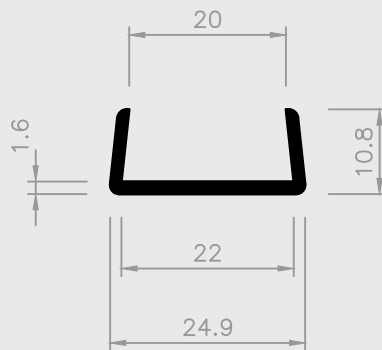

Nr. 42/36 H

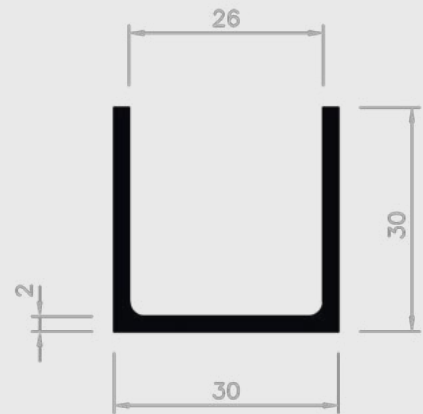

Nr. 63/36 H

■ = Hart PVC

■ = Weich PVC | HH = Halbhart PVC

□ = Andere Kunststoffe

# 24 | U - PROFILE

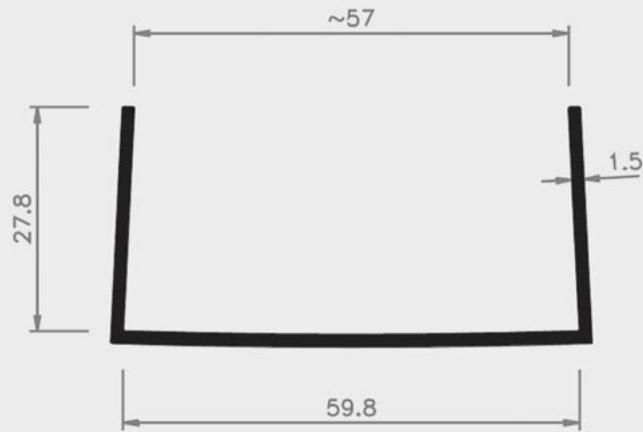

Nr. 39/36 H

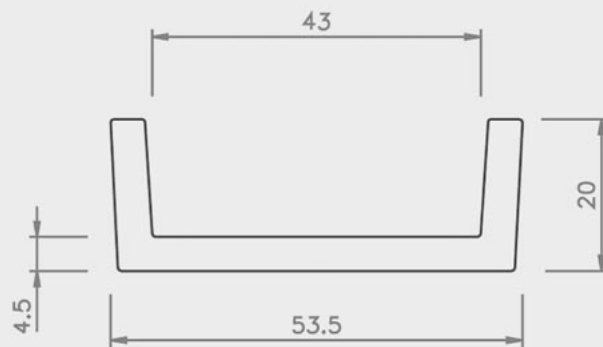

Nr. 51/36 PP

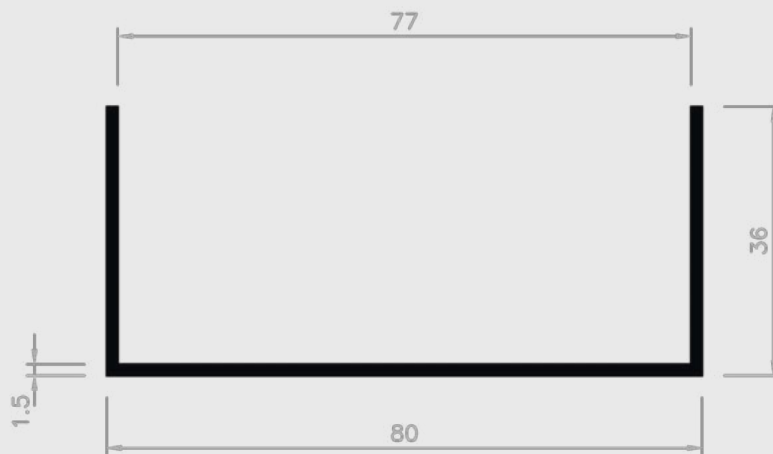

Nr. 39/37 H

■ = Hart PVC   ■ = Weich PVC | HH = Halbhart PVC   □ = Andere Kunststoffe

# 24 | U - PROFILE

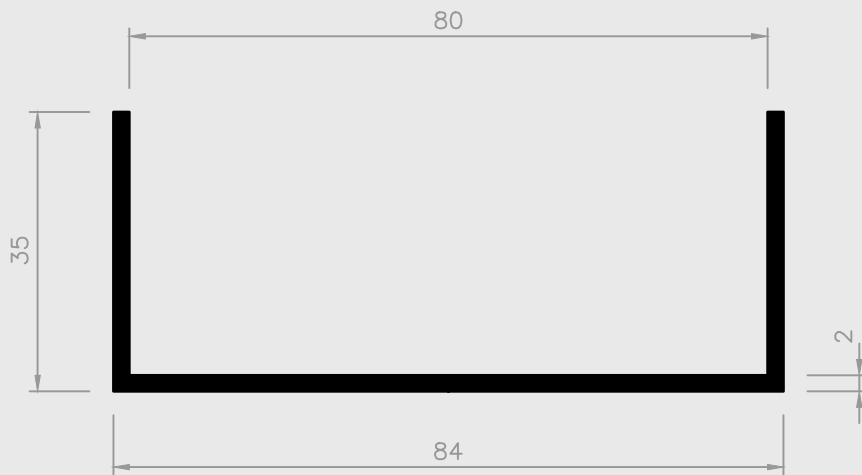

Nr. 42/21 H

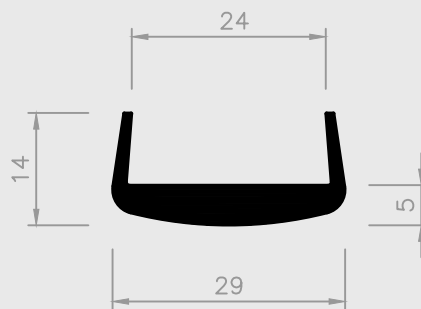

Nr. 35/36C H

■ = Hart PVC   ■ = Weich PVC | HH = Halbhart PVC   □ = Andere Kunststoffe